

Tables Folding

Materials Information

Leg Finish

Steel Leg Column

- a. Textured Black (standard)
- b. Chrome (standard)
- c. Blanc
- d. Noir
- e. Axel
- f. Folie
- g. Green Smoke
- h. Scotland Sky
- i. Minted
- j. Nocturnelle
- k. Pink Salt
- l. Zanilla

I-1080, I-1082, I-1084, I-1086 720 (standard Height)

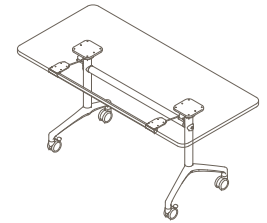
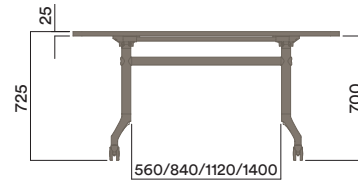
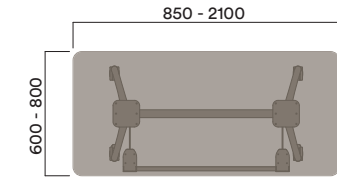

Foot Finish

Aluminium Foot

- a. Polished (standard)
- b. Powdercoat (to match column)

I-1081, I-1083, I-1085, I-1087 720 (standard Height)

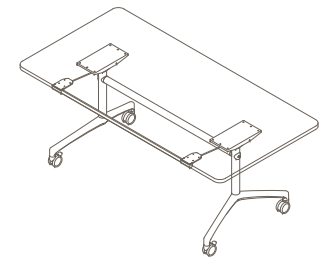
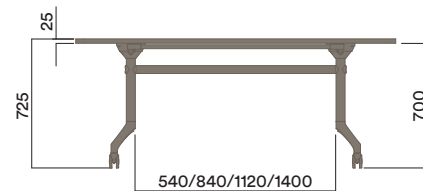
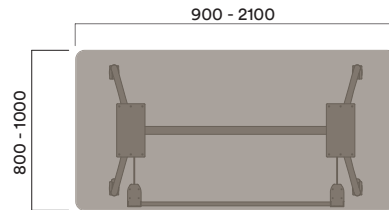

* Maximum Custom Height 1000mm on Glides
900mm on Castors
Maximum inc. worktop 24kg
Maximum Point Load 30kg
Seats 4 -6

1. Frame Finishes

Standard I.AM frame finishes include black or chrome legs with a polished foot. I.AM is also available in our current season powdercoat colours listed, with custom colour optional.

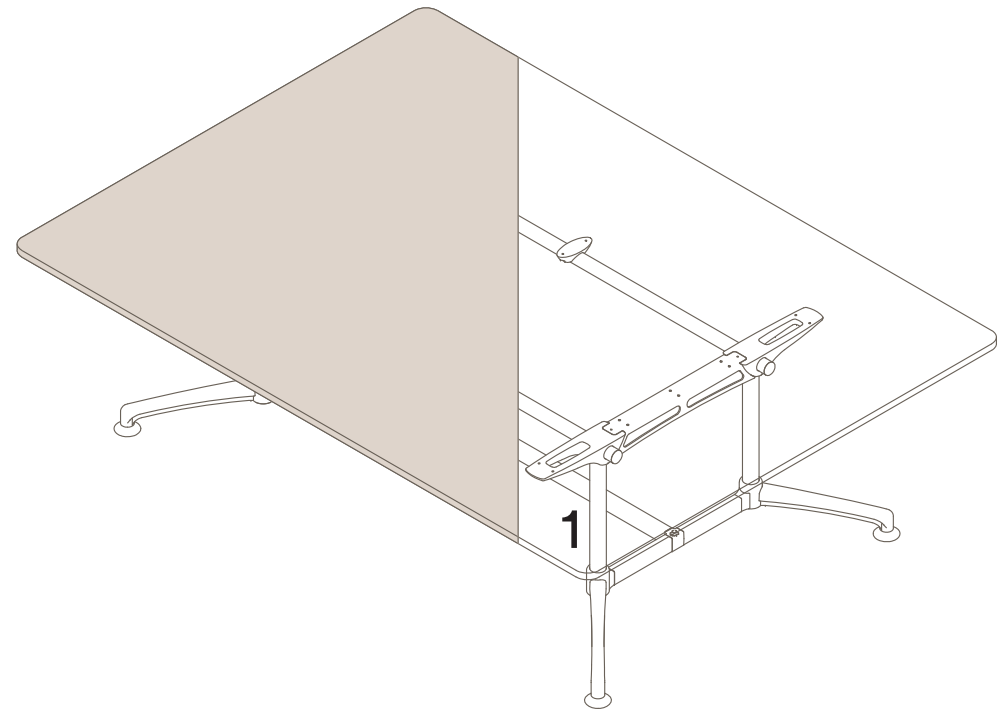
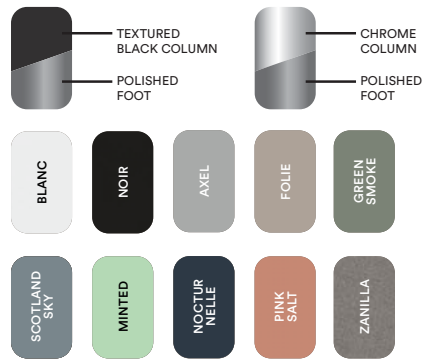

Colours are representative only, please check with your Thinking Works consultant to view samples of any specific colour.